

3D CAD MASTER PART NAME:

		ULTRA ALUMINUM MANUFACTURING, INC. 2124 GRAND COMMERCE DR. HOWELL, MI 48855 PHONE (800) 656-4420	
FIRST ISSUED		TITLE	
DRAWN BY		ULTRA MAX RAILING	
CHECKED BY		ADAMS TOP RAIL	
APPROVED BY		UMX-A200XX-XXXX-2RLS	
		REV 2 1-19-2018	
		SIZE DRG NO.	REV
		C	UMX-A200XX-XXXX-2RLS
		SCALE 1:1	SHEET 1 OF 2

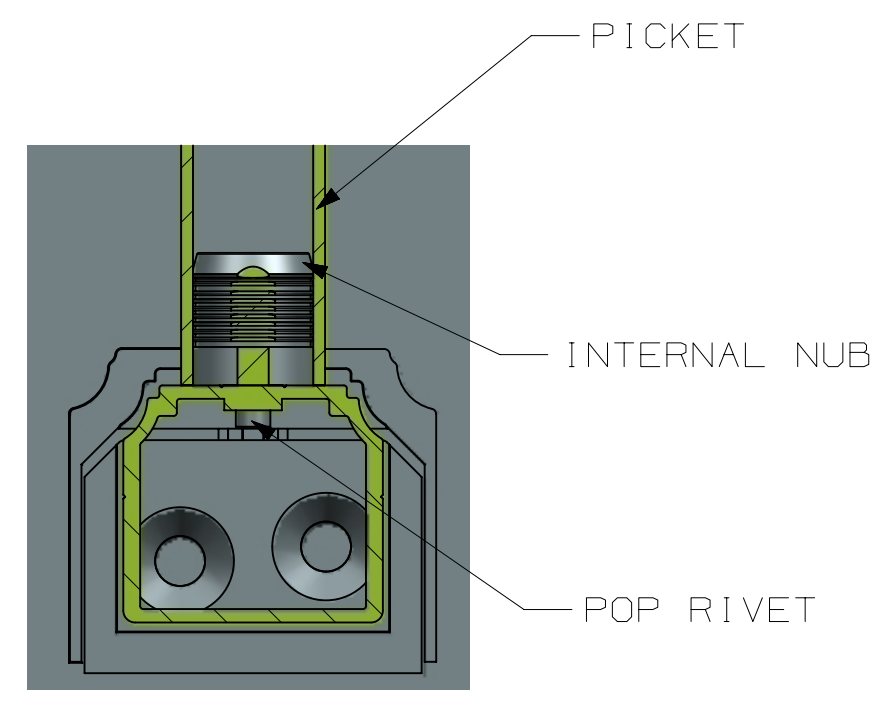
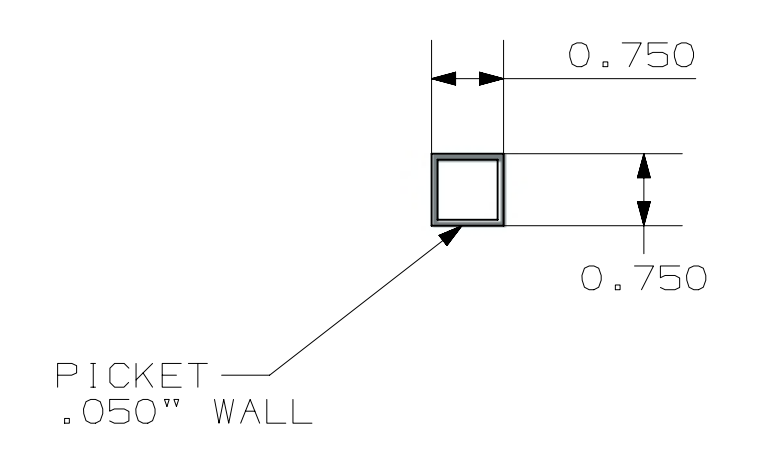
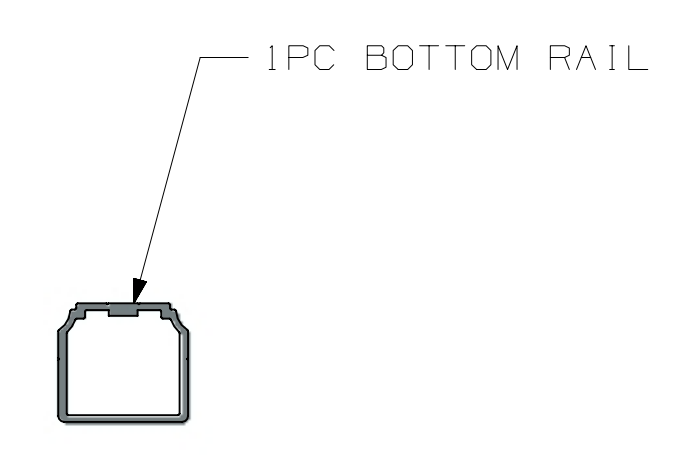
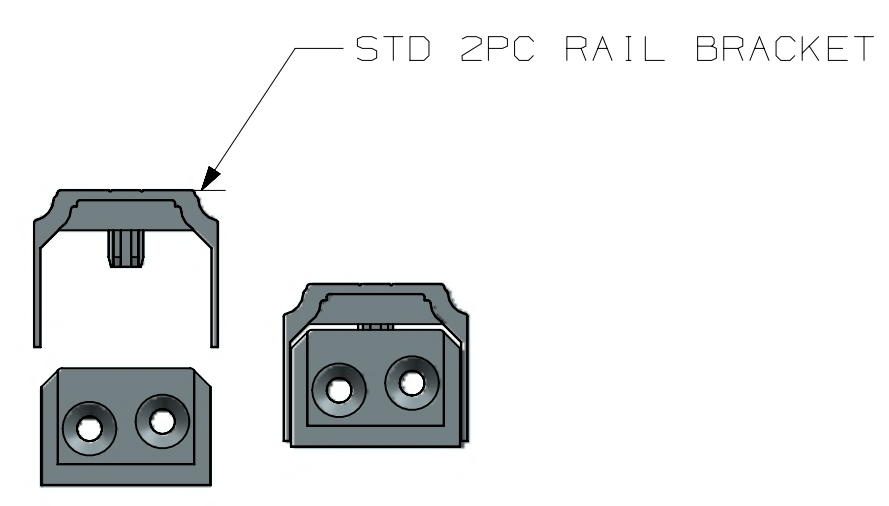
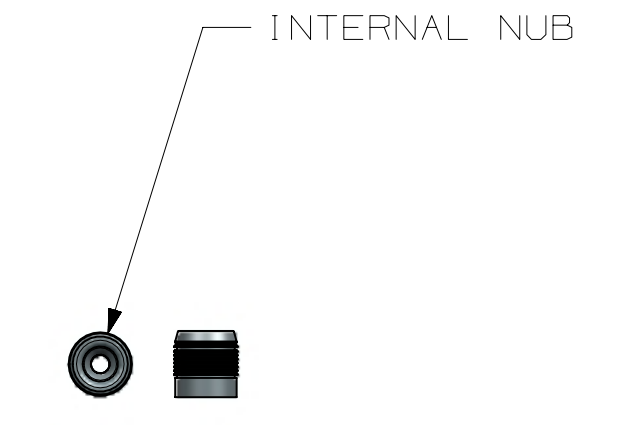
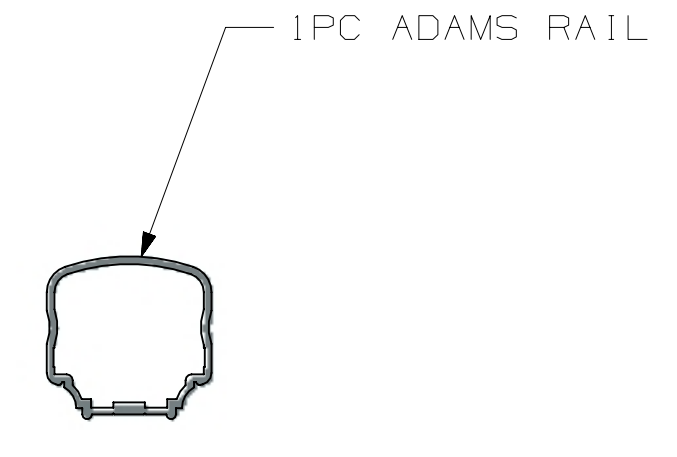
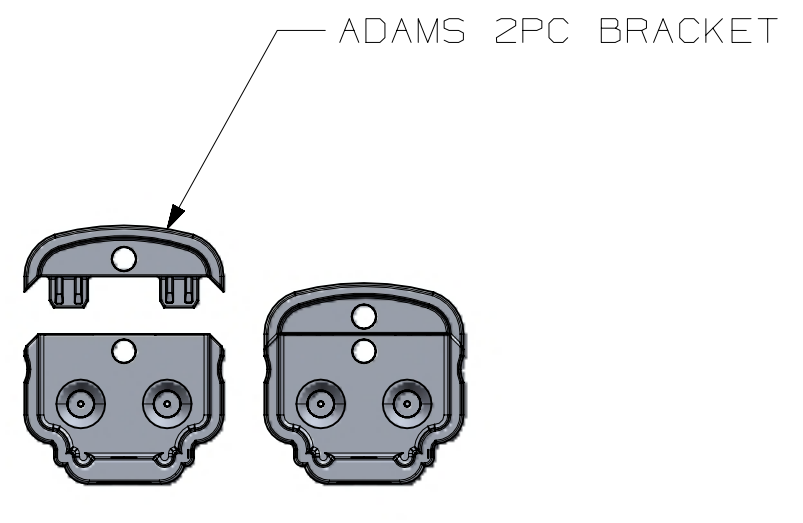
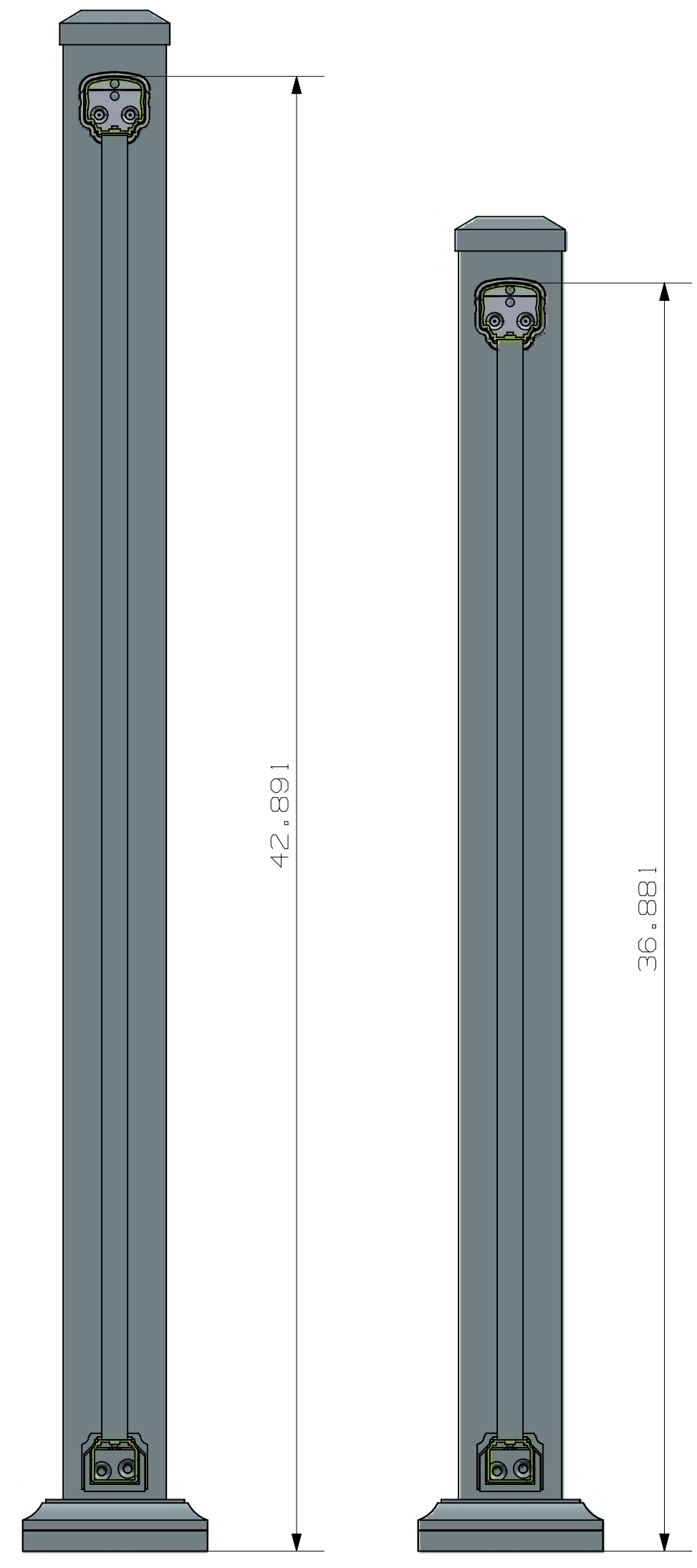
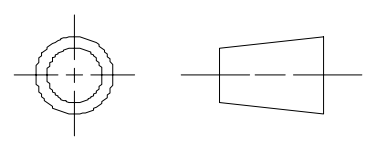

PANEL SIZE	RAIL LENGTH	FULL SIZE PICKET HEIGHT	NUMBER OF FULL SIZE PICKETS
36" X 4'	47 11/16"	32"	10
36" X 6'	70.00"	32"	15
36" X 8'	96 3/4"	32"	21
42" X 4'	47 11/16"	38"	10
42" X 6'	70.00"	38"	15
42" X 8'	96 3/4"	38"	21

3D CAD MASTER PART NAME:

		ULTRA ALUMINUM MANUFACTURING, INC. 2124 GRAND COMMERCE DR. HOWELL, MI 48855 PHONE (800) 656-4420	
FIRST ISSUED		TITLE	
DRAWN BY		ULTRA MAX RAILING	
CHECKED BY		ADAMS TOP RAIL	
APPROVED BY		UMX-A200XX-XXXX-2RLS	
		REV	
		SCALE 1:1	SHEET 2 OF 2